







20 000 715

- diamètre de percement 32 mm
- rosace 60 x 60 mm
- avec marquage chaud



S'adapte aux gammes suivantes : CL.1, CYO

| | | |
|---|-----------------------------|---------------|
|  | Dark Platinum brossé | 20 000 715-99 |
|  | Chrome | 20 000 715-00 |
|  | Platine brossé | 20 000 715-06 |
|  | Dark Chrome | 20 000 715-19 |
|  | Laiton brossé (Or 23cts) | 20 000 715-28 |
|  | Champagne brossé (Or 22cts) | 20 000 715-46 |
|  | Champagne (Or 22cts) | 20 000 715-47 |

20 000 715

mm [inches]



Diagramme de débit



Certificats

IAPMO_4976 (1). LGA_28688.

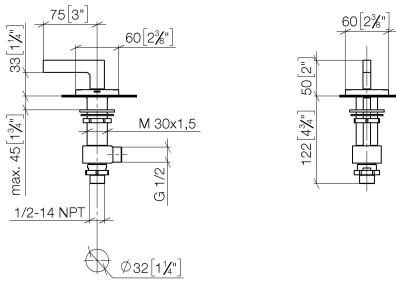
20 000 715

Les pièces pour les autres finitions peuvent être trouvées ici : Chrome

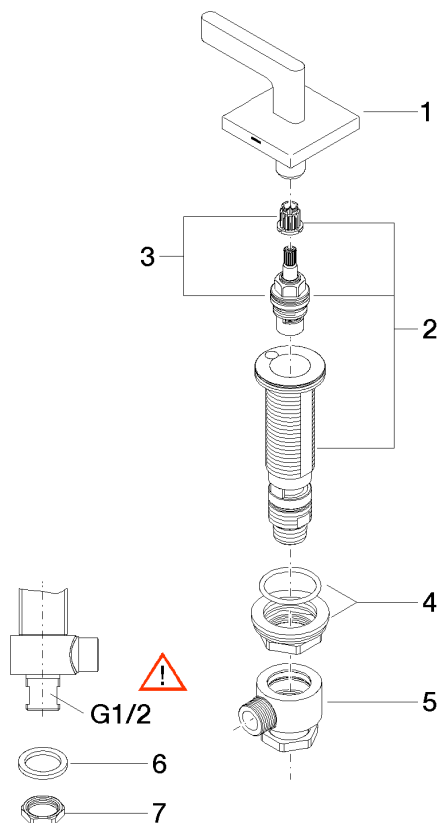

Liste des pièces de rechange

| N° | Article Numéro | Désignation | Fréquence de montage | Délai de livraison |
|----|--------------------|------------------|----------------------|--------------------|
| 1 | 90 20 70 057 00-99 | poignée (hot) | 1 | 30 |
| 2 | 04 17 11 058 33 90 | partie latérale | 1 | 2 |
| 3 | 90 90 03 133 00 90 | tête céramique | 1 | 2 |
| 4 | 04 23 10 032 78 90 | set de fixation | 1 | 2 |
| 5 | 04 17 11 023 10 90 | raccord multiple | 1 | 2 |
| 6 | 09 30 11 059 90 | rondelle | 1 | 2 |
| 7 | 09 23 10 012 90 | écrou | 1 | 2 |